



3 GHz BNC LATCHING S.P.4 T. SWITCH

OPTIONS : /SELF CUT-OFF /AUTO RESET / TTL DRIVE /SUPP.DIODES

R F CHARACTERISTICS

NUMBER OF WAYS : 4
 FREQUENCY RANGE : 0 - 3 GHz
 IMPEDANCE : 50 Ohms

FREQUENCY (GHz)	0 - 3
V.S.W.R <=	1.20
INSERT. LOSS <=	0.20 dB
ISOLATION >=	80 dB
AVER. POWER (*)	240 W

ELECTRICAL CHARACTERISTICS

ACTUATOR : LATCHING
 NOMINAL CURRENT AT 25° C (±10%) : 640 mA
 ACTUATOR VOLTAGE (Vcc) : 12V (10.2 to 13V) / NEGATIVE COMMON
 TERMINALS : solder pins (250°C max./30 sec.)
 SELF CUT-OFF TIME : 40 ms < CT < 120 ms
 TTL INPUTS (E) - High level : 2.2 to 5.5V / 800µA at 5V
 - Low level : 0 to 0.8V / 20µA at 0.8V

MECHANICAL CHARACTERISTICS

CONNECTORS : BNC female per MIL C 39012
 LIFE : 2.000.000 cycles per position
 SWITCHING TIME (nominal voltage;25° C) : < 40 ms
 CONSTRUCTION : splashproof
 WEIGHT : < 460 g

ENVIRONMENTAL CHARACTERISTICS

OPERATING TEMPERATURE RANGE (°C) : -40 , +85
 STORAGE TEMPERATURE RANGE (°C) : -55 , +85

(* : average power at 25° C per RF path)

4112-9212 This information is given as an indication. In the continual goal to improve our products, we reserve the right to make any modifications judged necessary

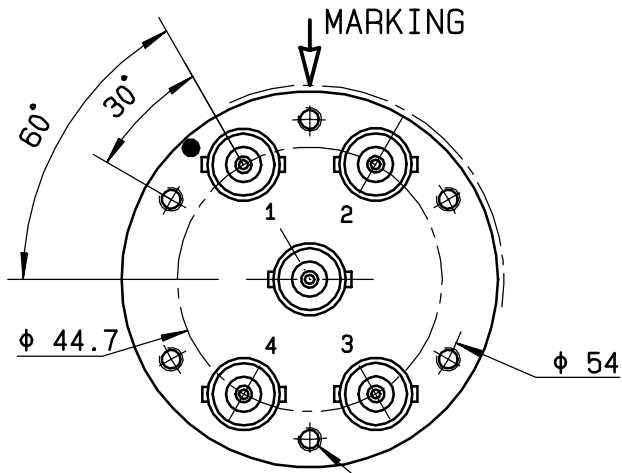

TTL input	RF continuity
E1 = 1	IN ↔ 1
E2 = 1	IN ↔ 2
E3 = 1	IN ↔ 3
E4 = 1	IN ↔ 4

TERMINALS
6 holes M4 /60°
depth 5 min

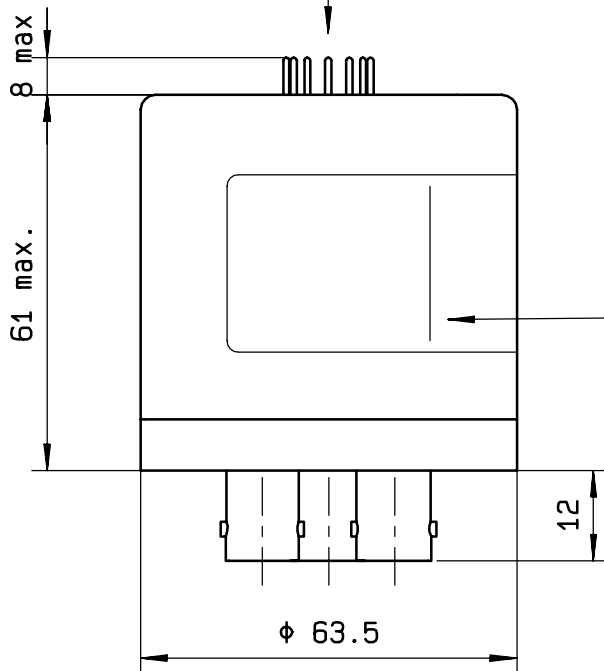

MARKING TOP VIEW (TERMINALS)

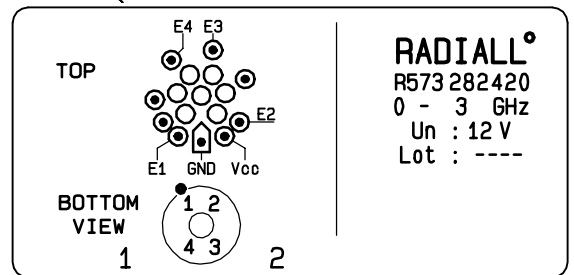

SCHEMATIC DIAGRAM

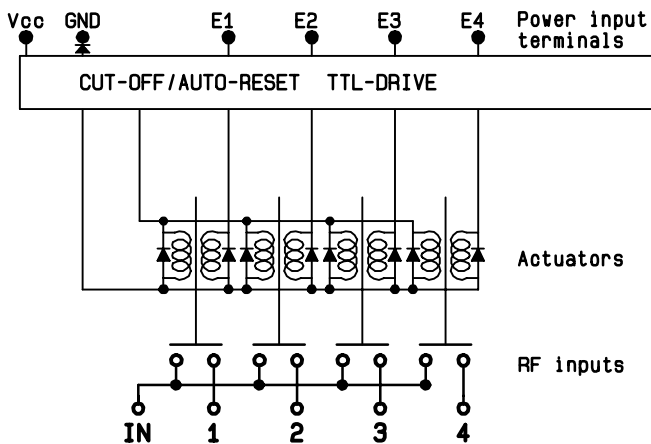

4113-9212 This information is given as an indication. In the continual goal to improve our products, we reserve the right to make any modifications judged necessary